

### STEP 1

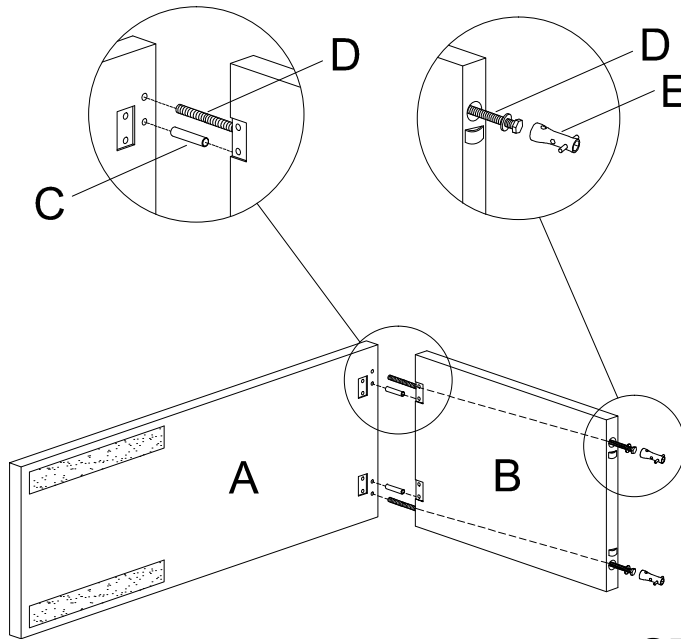

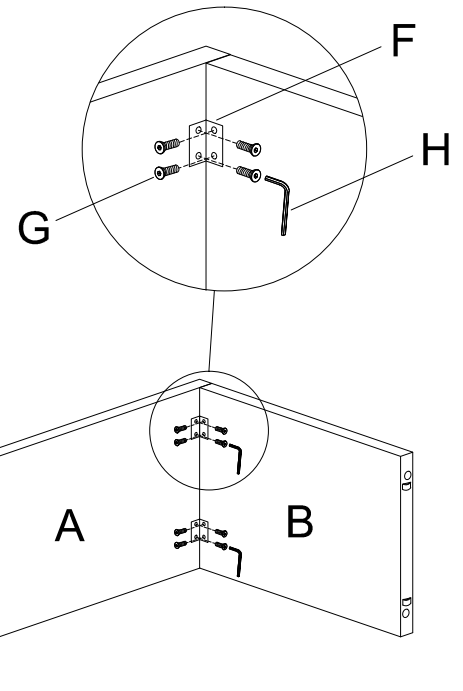



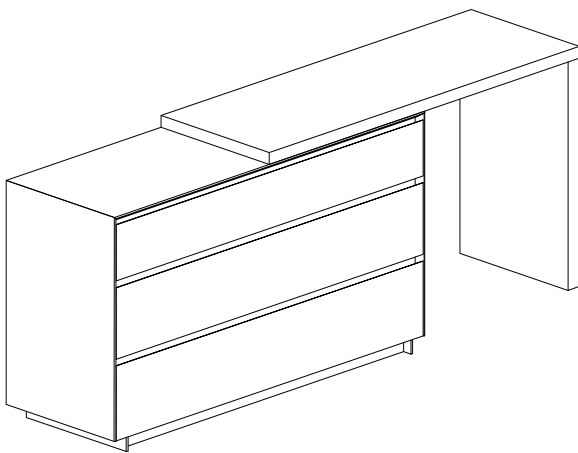

### STEP 2

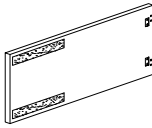
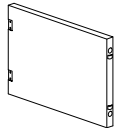

### FINISHED



NO.	A	B	C	D	E	F	G	H
DIAGRAM	 1240x450x40	 690x449x40	 10x40	 5/16"x700		 50x30x30	 1/4"x20	
QUANTITY	1x	1x	2x	2x	1x	1x	1x	4x



\*GENERAL NOTE : ALWAYS PLACE OBJECTS ON A SMOOTH SURFACE TO AVOID SCRATCHES.

